



A Microwave Power Meter with a Hundredfold Reduction of Thermal Drift

A basic limitation in bolometer type power meters has been the drift that thermal changes cause in the power meter zero reading. Such drift not only sets a practical limit to the lowest power levels that the meter can measure but has often constituted a considerable inconvenience at higher levels as well.

SEE ALSO:
"A Low-Cost DC Fan," p. 6

A new microwave power meter has been developed which has only about a hundredth of the thermal drift susceptibility of uncompensated power meters. This has permitted the new meter to have a 10 times increase in sensitivity and to be more

stable at this low level than previous meters were at higher levels.

The new power meter measures down to 10 microwatts full scale on its lowest range and up to 10 milliwatts full scale on its highest range. Its frequency coverage is determined by accessory bolometer mounts which have been designed both in waveguide and in coaxial versions. For waveguide use, a series of mounts has been designed for guide sizes between 2.6 and 40 gc (kmc). For coaxial systems, a single mount operates over the full range from 10 mc to 10 gc.

The new power meter further includes an important feature for power-measuring equipment. This is an output for operating an ex-

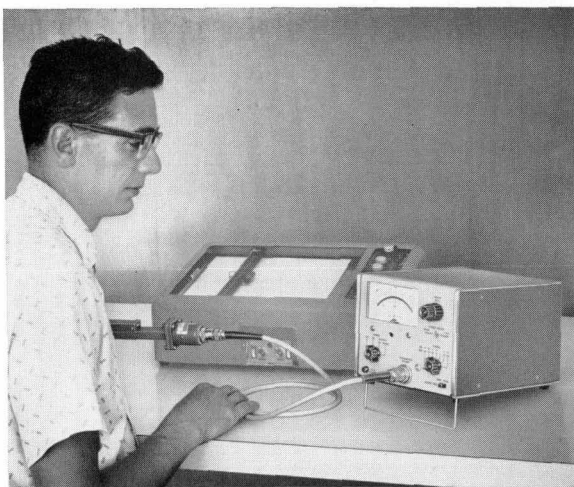

Fig. 1. New -hp- Microwave Power Meter has increased sensitivity and stability, permitting measurements down to 10 microwatts full scale with accessory waveguide and coaxial bolometer mounts. Instrument also provides output for operating recorders or for leveling power sources.

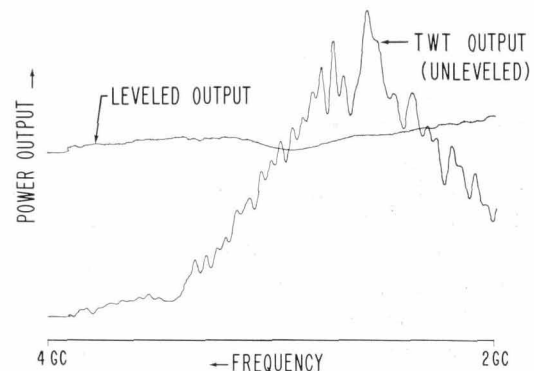

Fig. 2. Comparison of unlevelled output of traveling-wave tube amplifier with output when leveled using new power meter in arrangement described in text.

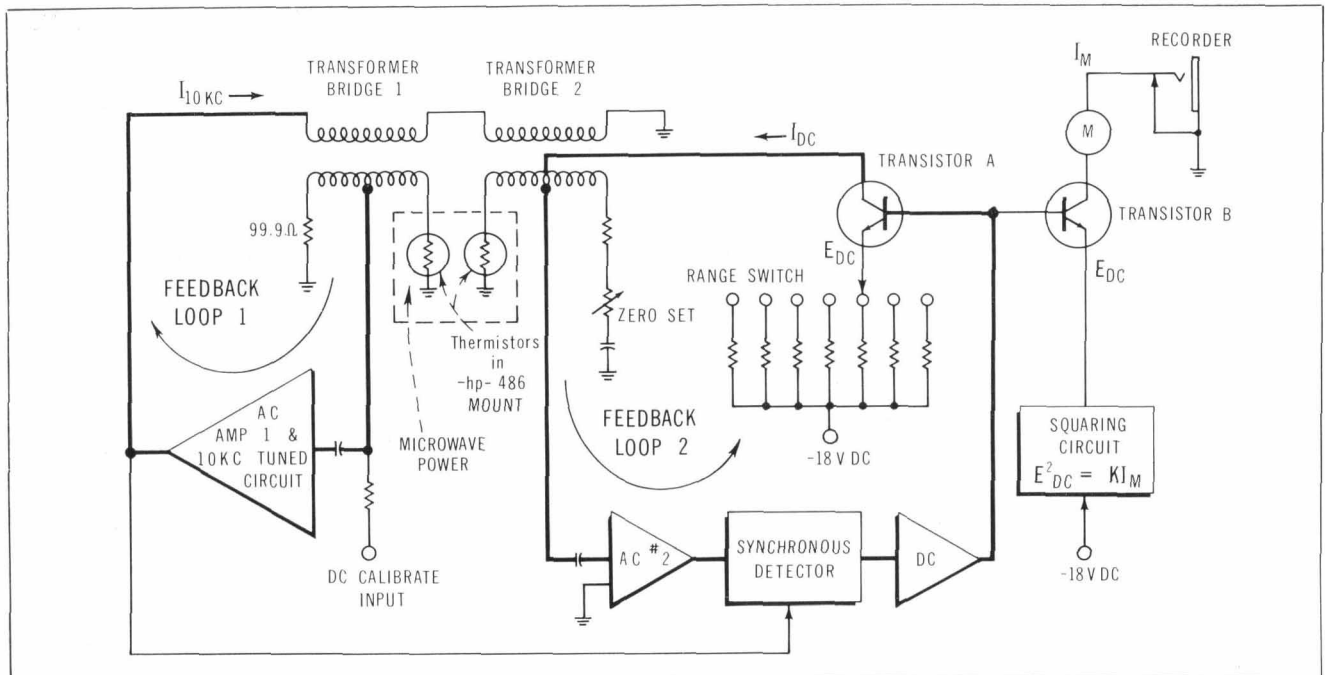

Fig. 3. Basic circuit arrangement of -hp-431A Power Meter. High thermal stability occurs from use of double-bridge technique with compensated thermistor mounts.

ternal strip-chart or X - Y recorder. With this output it becomes convenient to obtain permanent records of microwave power as a function of temperature, frequency, time, etc. In addition, the output enables the power meter to be used in leveling the power produced by swept-frequency sources and in obtaining a digital readout of power, as described later.

Several other interesting features are included in the new instrument. It has an increased accuracy of $\pm 3\%$ which can be made even higher by a special technique described later. It is transistorized, achieving reduced size and weight and permitting operation from an optional internal battery. The battery is rechargeable in place when the instrument is operated from a power line. Finally, the instrument has considerable convenience of operation. For example, zero setting of the lowest range carries over to all higher ranges, while the only controls used in usual operation are the fine zero and range controls. Indeed, on the higher ranges the

range control may be the only control used.

CIRCUIT DESIGN APPROACH

Fig. 3 shows the effective circuit arrangement when the new power meter is operated with one of its companion bolometer (thermistor) mounts. The mount includes two thermistor elements, one of which absorbs the rf or microwave power

to be measured. The action of the second thermistor is described below.

The power meter circuitry consists of two bridges which are made to be self-balancing through the use of feedback loops. Each bridge incorporates one of the thermistor elements as one of the bridge arms. In loop #1 amplifier #1 supplies 10 kc power to bias the thermistor to the resistance necessary to balance

THERMISTOR MOUNTS FOR -hp- 431A POWER METER

MOUNT	FREQ. COVERAGE	TYPE	MAX. VSWR	RESISTANCE
478A	10 mc — 10 gc	Coaxial — Type N Connector	*	200
S 486A	2.6 — 3.95 gc	3 x 1½" Waveguide	1.35	100
G 486A	3.95 — 5.85 gc	2 x 1" Waveguide	1.5	100
J 486A	5.3 — 8.2 gc	1½ x ¾" Waveguide	1.5	100
H 486A	7.05 — 10.0 gc	1¼ x ⅝" Waveguide	1.5	100
X 486A	8.2 — 12.4 gc	1 x ½" Waveguide	1.5	100
M 486A	10.0 — 15.0 gc	0.850 x 0.475" Waveguide	1.5	100
P 486A	12.4 — 18.0 gc	0.702 x 0.391" Waveguide	1.5	100
K 486A	18.0 — 26.5 gc	½ x ¼" Waveguide	2.0	200
R 486A	26.5 — 40.0 gc	0.360 x 0.220" Waveguide	2.0	200

*1.3 from 20 mc to 7 gc, 1.5 from 10 mc to 10 gc.

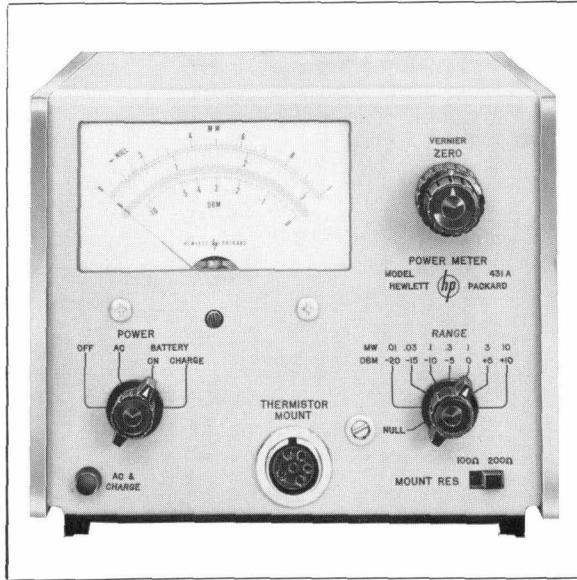

Fig. 4. New power meter is transistorized and can be operated from optional internal battery.

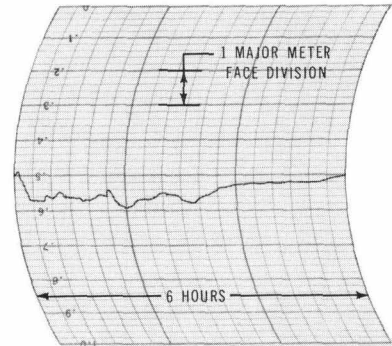

Fig. 5. Six-hour recording of room-condition zero-drift on most sensitive range of new power meter shows high stability achieved. This drift then becomes attenuated by range factor on higher ranges.

bridge #1. An equal amount of this 10 kc power is supplied by amplifier #1 to the second thermistor through the two series-connected transformers. Bridge #2 is thus also balanced (assuming that the zero control has been adjusted).

When rf power is now applied to thermistor #1, an amount of 10 kc power equal to the rf is displaced from the thermistor by the self-balancing action of the bridge. Because of the series-connected transformers, an equal amount of 10 kc power is also displaced from thermistor #2. Bridge #1 thus remains balanced, but bridge #2 must be rebalanced by its feedback loop. This balancing occurs automatically, but the balancing is performed with dc power instead of 10 kc power as in the first bridge and this dc is applied only to bridge #2. The dc power applied to thermistor #2 to balance the bridge is thus equal to the microwave power originally applied to thermistor #1. The dc power applied to thermistor #2 is then monitored by transistor B which operates the meter circuit. A squaring circuit makes the meter indication linear in power. The meter circuit also includes an output for operating an external recorder.

STABILITY WITH TEMPERATURE CHANGES

That there is very little drift of the power meter zero point when the ambient temperature changes can now be easily demonstrated. Assume, for example, that there is an increase in ambient temperature at the thermistors. In such a case a decrease in electrical power is needed at the thermistors to maintain their operating resistance constant. This decrease is automatically performed for both thermistors by loop #1 which decreases the amount of 10 kc power by the appropriate amount. The amount of dc power in loop #2 remains fixed, however, and since this dc power is the power that is metered it can be seen that the temperature change has not affected the meter reading. This action assumes that the two thermistors are identical as to their temperature characteristics. In practice, these are matched at $-hp-$ so that the zero point change with ambient temperature change is extremely small.

DRIFT CHARACTERISTICS

The practical result of the design approach described above is shown in the drift record of Fig. 5. This record shows the drift under typical laboratory conditions for the most

sensitive ($10 \mu w$) range of the new power meter for a six-hour period. For this whole period the total drift excursion is only about 1 major meter scale division, i.e., about 1 microwatt peak-to-peak. Even this small drift, since it is for the most sensitive range, will be attenuated by the range factor on higher ranges with the result that it becomes virtually unobservable on any but the most sensitive range.

LINEAR OUTPUT FOR RECORDING

The recorder output provided at the back of the instrument produces a current of 1 ma for a full scale power reading. This current can be delivered to loads of up to 2000 ohms. It is linearly related to the power reading so that not only will recordings made from this output be direct-reading in power but it also becomes easy to obtain a digital readout of power. For example, placing a digital voltmeter shunted by a 1000-ohm resistor across the recorder terminal will make the digital voltmeter direct-reading in power on the power meter's "1" - "10" - "100", etc., ranges except for positioning of decimal point. Similarly, a 316-ohm resistor will make the "3" - "30" - "300", etc., ranges

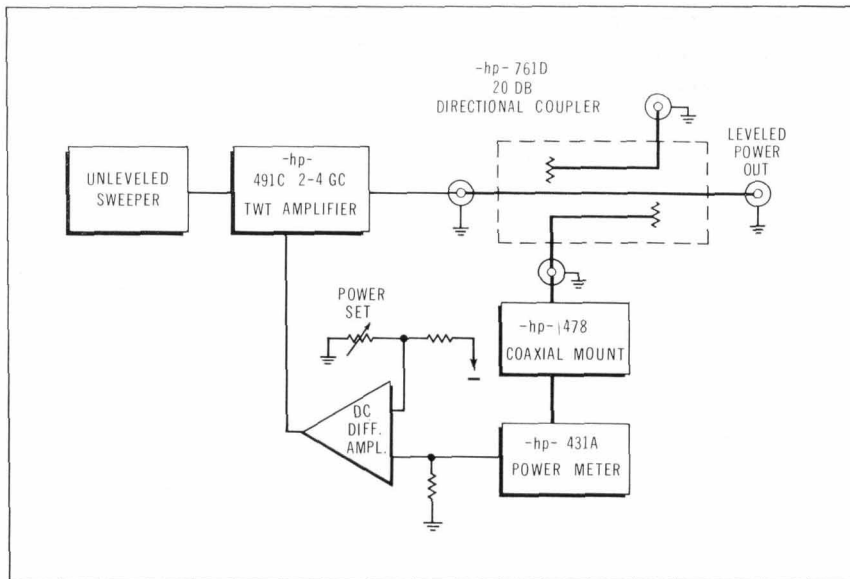

Fig. 6. Equipment arrangement used with new power meter to obtain leveled, high-power 2-4 gc sweep-frequency signal source.



Fig. 7. -hp- 486A waveguide thermistor mount (upper) has been designed in guide sizes from 2.6 to 40 gc. Model 478A coaxial mount (lower) operates from 10 mc to 10 gc.

direct reading. If desired, the digital voltmeter can be followed with a printer to obtain a printed record of power measurements. Where greater sophistication is required, the new power meter can be combined with -hp-/Dymec Division automatic data-logging equipment to record power readings on punched cards or printed records.

Because of the excellent thermal and time stability of the new meter, power loss alarm and protection systems can be easily formed using the recorder output provision.

LEVELED POWER SYSTEMS

The recorder output feature has also proved valuable in other ways. Fig. 6, for example, shows an arrangement in which a leveled, high-power 2 - 4 gc swept frequency source is formed using the new power meter in the feedback loop. In this arrangement the output of the sweeper is fed to an -hp- 491C 30 db traveling-wave amplifier. This produces an output of up to 1 watt which is monitored by the power meter operating with a 20 db directional coupler. The power meter output is then applied to the modulating electrode on the twt through a suitable amplifier. By means of a shaping network the amplifier characteristic is designed to be the inverse of the transfer characteristic of the twt so that the system loop gain is about the same at all levels.

The effectiveness of this leveling

system is shown by the curves in Fig. 2 (first page) which compare the leveled output with the output before leveling. The leveled output is essentially constant with frequency except for the small variation due to the change in coupling of the directional coupler.

In addition to acting as a leveler, the system also acts as a power-set system, because the power produced at the output of the coupler is controlled by the position of the power meter range switch as well as by the power set potentiometer. The potentiometer gives a continuous vernier on power output, while the range switch on the power meter acts as a 5 db step attenuator in controlling power.

The cutoff frequency of the feedback system indicated in Fig. 6 is about 10 cps. Therefore, in operation the sweeper must be set to sweep slowly enough so that the fine structure in the unleveled output can be removed.

IMPROVED SOURCE SWR

It should also be noted that the leveling system shown in Fig. 6 improves the apparent swr of the resultant power source. This occurs because the leveling system holds constant the wave traveling toward the load despite energy reflected back from the load.

MEASUREMENT ACCURACY CONSIDERATIONS

In microwave power measurements there are generally considered to be four major sources of error: (1) mismatch error or tuner loss, (2) bolometer mount efficiency, (3) substitution error, and (4) instrumentation error.

Mismatch loss occurs when the power-absorbing device does not present an impedance that is the complex conjugate of that seen looking toward the source. If one of the two impedances corresponds to unity swr, then mismatch loss can be cal-

culated from the other swr. Usually, however, neither swr is unity. In such a case the loss can only be expressed as lying between two limits. A tuner can be used to minimize the mismatch loss, although the tuner itself will introduce some loss.

Bolometer mount error occurs because some of the applied power is dissipated within the mount before reaching the bolometer element. In addition, substitution error results when the rf power does not affect the thermistor element to the same degree as dc power. This error is usually less than 1%.

Substitution error and mount efficiency are often combined for simplicity of measurement into what is termed "calibration factor". Typically, the calibration factor of the -hp- X486A waveguide mount for the new power meter is .97 or .98, although no efficiency specification is quoted. All -hp- mounts are, however, checked against a "house control" mount and those that are significantly low in efficiency are rejected.

It is possible to obtain the calibration factor of an X-band mount from the National Bureau of Standards to an accuracy of 1%. NBS does not presently measure this factor in mounts in other than X-band nor in coaxial mounts above 300 mc.

The fourth source of error is instrumentation error. This is the inability of the power meter to accurately measure and interpret the information available at the thermistor element. In specifying the accuracy of a power meter, instrumentation error is the figure usually used. In the new power meter, this error is rated at 3% maximum but can be made smaller, as described next.

DC CALIBRATION

For situations in which it may be desirable to minimize instrumentation error, the new power meter has been equipped with a dc calibration

and substitution terminal at the back of the instrument. Use of this terminal makes it possible to reduce instrumentation error to less than 1% through the following dc-substitution technique: With microwave power applied to the appropriate mount, a digital voltmeter or differential voltmeter can be connected across a resistor which in turn is connected across the power meter recorder output. The voltmeter can now obtain a high resolution reading related to the power measured by the power meter. The microwave power can now be turned off and dc applied to the dc calibration terminal on the power meter until an indication equal to the previous indication is obtained on the voltmeter. The power is now $I_t^2 R_t$ where I_t is dc current applied to the thermistor and R_t is the resistance of the thermistor (100 or 200 ohms, depending on the particular mount). The resistance of the mount is within 1% of the nominal value and can be determined to within a few tenths of a percent if desired. If the dc current is accurately measured this arrangement will thus give better than 1% accuracy.

PORTABLE OPERATION

The optional internal battery is designed to give up to 24 hours of portable operation without recharge. The battery can be installed at any time and is designed to be recharged in place when the instrument is connected to a power line. When the panel switch is in the "Charge" position, the battery is charged at a rate (32 ma) that permits indefinite charging without damage. In normal operation the battery, if present, receives a trickle charge to assure maintenance of full charge.

The battery operation feature combined with the low thermal drift of the new power meter make portable operation practical even under adverse environmental conditions.

ACKNOWLEDGMENT

The double bridge technique employed in the new power meter was conceived by George Jung. The waveguide thermistor mounts were designed by James Vaughan, while the coaxial mount was designed by E. L. Miller and Robert Mouw. The power meter design team consisted of George Jung, William Hanisch and the author. Project leader was Marco R. Negrete.

—R. F. Pramann

SPECIFICATIONS

-hp- MODEL 431A POWER METER

Power Range: 7 ranges with full scale readings of 10, 30, 100 and 300 μ w; 1, 3 and 10 mw. Also calibrated in dbm from -30 to +10.

External Bolometer: Temperature-compensated thermistor mounts required for operation (-hp- 478A or 486A).

Accuracy: $\pm 3\%$ of full scale on all ranges from 20° to 35°C.

$\pm 5\%$ of full scale on all ranges from 0° to $\pm 52^\circ$ C.

Recorder Output: Phone jack on rear provides 1 ma maximum into 2000 ohms maximum. Calibration and Substitution Input: Binding posts on rear for calibration of bridge with precise dc standards or making accurate dc substitution measurements.

Power Supply: 115/230 volts $\pm 10\%$, 50 to 1000 cps, 1/2 watts.

Dimensions: 6 1/2" high, 7 3/4" wide, 12" deep.

Weight: Net 6 1/2 lbs.; 9 1/2 lbs. with battery.

Accessories Furnished: 5-foot cable for -hp- temperature compensated thermistor mounts (-hp- 431A-16A).

7-foot power cord set (-hp- 8120-0078).

Accessories Available: Temperature compensated thermistor mounts: See below.

Rechargeable battery with installation kit (-hp- 431A-95A): \$100 either factory installed or as separate kit.

Price: Model 431A Power Meter: \$345.00.

-hp- MODEL 478A COAXIAL THERMISTOR MOUNT

Frequency Range: 10 mc to 10 gc (kmc). SWR: Less than 1.5; less than 1.3 from 20 mc to 7 gc.

Power Range: 1 μ w to 10 mw.

Elements: Permanently installed thermistors. Operating Resistance: 200 ohms, negative temperature coefficient.

RF Connector: Type N, male.

Bridge Connector: Mates with cable supplied with -hp- Model 431A.

Dimensions: 3 1/4" long, 1 3/8" max. diameter.

Weight: Net 5 1/2 oz.

Price: \$145.00.

-hp- MODEL 486A THERMISTOR MOUNTS

Power Range: 1 μ w to 10 mw with -hp- 431A Power Meter.

Elements: Permanently installed thermistors. Operating Resistance: 100 or 200 ohms, depending on guide size; see table p. 2. Negative temperature coefficient.

Bridge Connector: Mates with cable furnished with -hp- Model 431A Power Meter.

Price: -hp- Model X486A (8.2 to 12.4 kmc): \$145.00. Prices for other frequency ranges on request.

For additional data see table elsewhere in this issue.

Prices f.o.b. Palo Alto, Calif.

Data subject to change without notice

A NEW LOW-COST DC FAN FOR CABINET COOLING

Where electronic equipments are intended to operate over a range of power line frequencies (50 to 1600 cps being a common example), a problem results if the equipment is fan-cooled. This is that the inexpensive and quiet ac-type fan motor must be replaced with an expensive and noisy dc motor which has the additional disadvantage of brush wear problems.

To avoid these disadvantages and to achieve much greater economy, *-hp's* affiliate, PAECO*, has designed a new dc-operated fan. It consists of a conventional ac shaded-pole motor which is powered from a simple transistorized dc inverter. The new fan thus overcomes the line-frequency problem and in so doing achieves a 50% or more economy over conventional dc fan arrangements. The unit has a 4" fan blade and delivers 125 cfm in free air.

As shown in Fig. 1, the fan motor and inverter are constructed as separate units. This permits the inverter to be mounted in a location where it will not interfere with the air flow path.

*PAECO (Palo Alto Engineering Co.) is *-hp's* affiliate for the design and manufacture of transformers and other magnetic components. It is located at 620 Page Mill Road, Palo Alto, Calif., Tel. DA 6-5360.

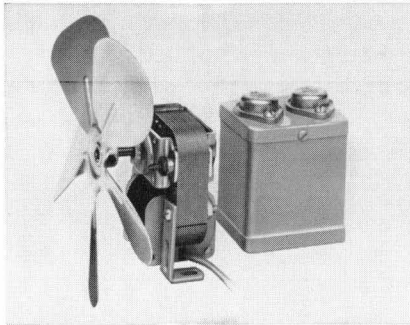

Fig. 1. New PAECO fan enables long life and quietness of ac fan motor to be obtained in variable line frequency applications.

The operation is such that a higher air flow is obtained than is customary with a motor of the size used. This occurs because the fan motor is operated at a frequency somewhat higher than 60 cps. Ratings are still conservative, however, and the motor coil temperature rise is only 15°C above a 25°C ambient. A comparison of torque characteristics for the motor when 60-cps operated and when inverter operated appears in Fig. 2 and shows the rpm improvement obtained.

To cover a wide range of conditions, the unit has been designed to operate over the temperature region from -20°C to +40°C. Low temperature operation has been achieved by an

arrangement that compensates for the drop in $dc-\beta$ of the switching transistors in the inverter at low temperatures, while temperature stabilization is employed to provide reliable high temperature operation.

With the exception of the two transistors, all inverter components are potted inside a transformer type housing for maximum resistance to shock, vibration, and humidity. The transistors are located on the housing lid so as to be readily available for servicing. The lid also serves as the transistor heat sink. The components within the housing operate with low temperature rise since the potting compound has been selected for good thermal conducting properties. Temperature rise of the housing is approximately 25°C above a 25°C ambient.

The external field generated by the fan motor is comparable to that resulting when the motor is operated from its standard 115v/60 cps conditions.

The new fan can be supplied to operate from any supply voltage in the range from 12 to 24 vdc.

The inverter itself can be mounted in any convenient location within a cabinet and has dimensions of only 2¼"x2"x2½".

The electrical and mechanical design of the new fan were performed at PAECO by Ned E. Baxter and C. J. Biggerstaff, section head, of the magnetic applications group.

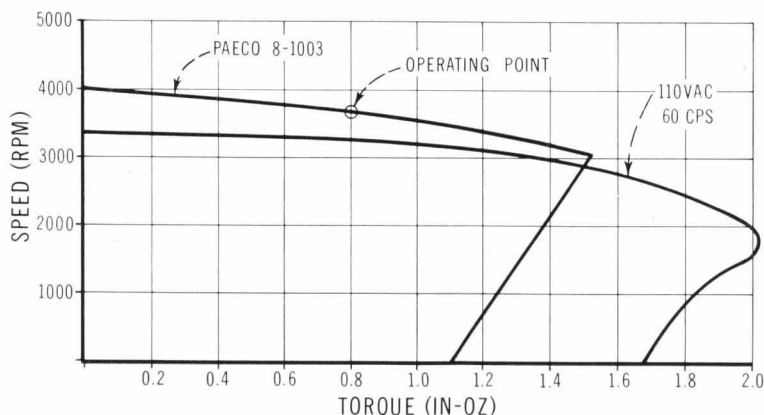

Fig. 2. Torque characteristic of fan motor as used in new fan and as obtained with 110 v, 60 cps operation.

SPECIFICATIONS Paeco MODEL 8-1003 DC FAN

DC Input Voltage Range: 12 to 24 vdc.

Typical operation at 18 vdc $\pm 10\%$:
DC Input Voltage Permissible Ripple: 1
v_{rms}.

DC Input Current: 3.0 adc $\pm 20\%$.
Motor RPM (No Load) at 25°C: 4000 rpm.
Motor RPM (Full Load) at 25°C: 3700 rpm.
Operating Temperature Range: -20°C to
+40°C.

Fan Motor Type: 5/8" shaded pole.
Starting Voltage at 25°C: 2v minimum.
Volume of Driver Unit: Approx. 12 cu. in.
Weight: 0.4 lbs.

Air Delivery: 125 cfm free air.
Price: Approx. \$27.00; depends on quantity.
Prices f.o.b. Palo Alto, Calif.

Data subject to change without notice